

○ Floor Joist Over Foundation Wall

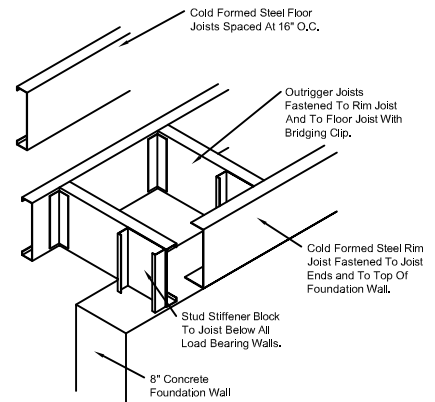

○ Floor Joist Outrigger Detail

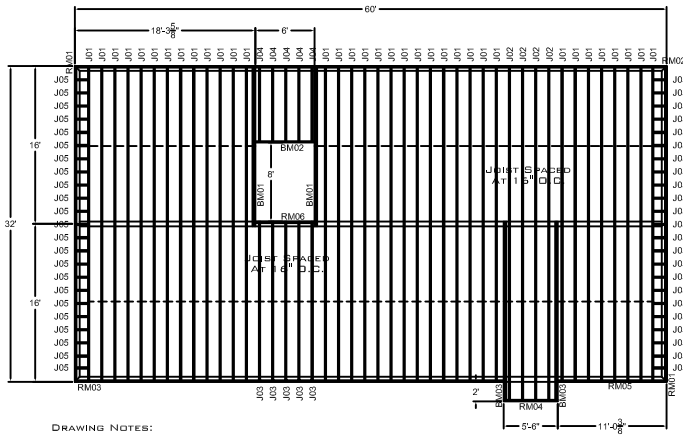

DRAWING NOTES:
 - - - BLOCKING LOCATIONS
 ALL JOIST DIMENSIONING IS APPROXIMATE. INSTALLER TO VERIFY ALL DIMENSIONS ON SITE PRIOR TO INSTALLING TRUSSES

○ JOIST LAYOUT N.T.S.

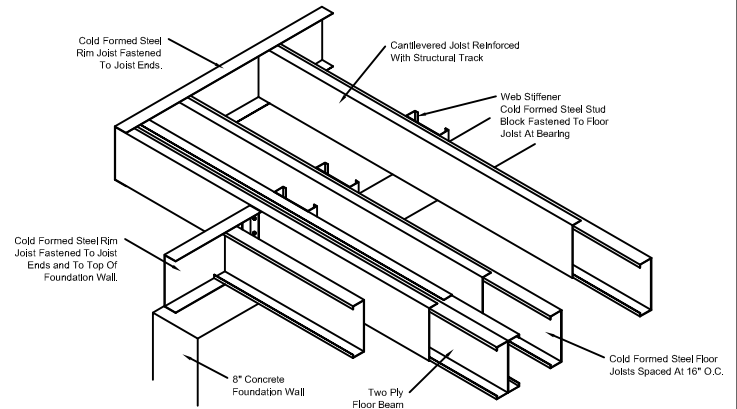

○ Cantilevered Floor Detail

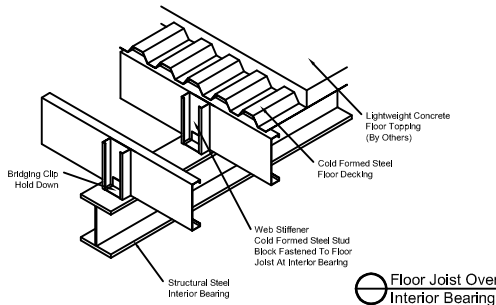

○ Floor Joist Over Interior Bearing

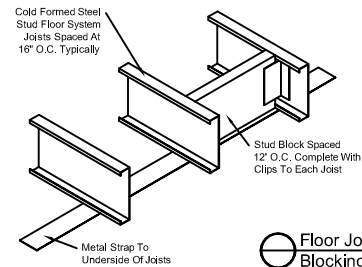

○ Floor Joist Blocking Detail

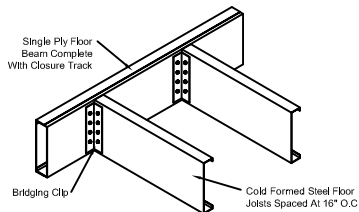

○ Floor Joist To Beam Connection

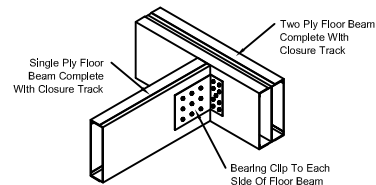

○ Floor Beam To Floor Beam Connection

Location: Typical

Scale: N/A

Date: 2008

Cold Formed Steel
Flooring Details

Design: JWV

Drawn: JV

4427 VanderWal Dr.
P.O. Box 878
Petrolia On, NON IRO
Toll Free: 1-877-251-6875
Fax: 519-882-4153
Email: info@trusses.ca

VanderWal
Commercial Group